

Top View

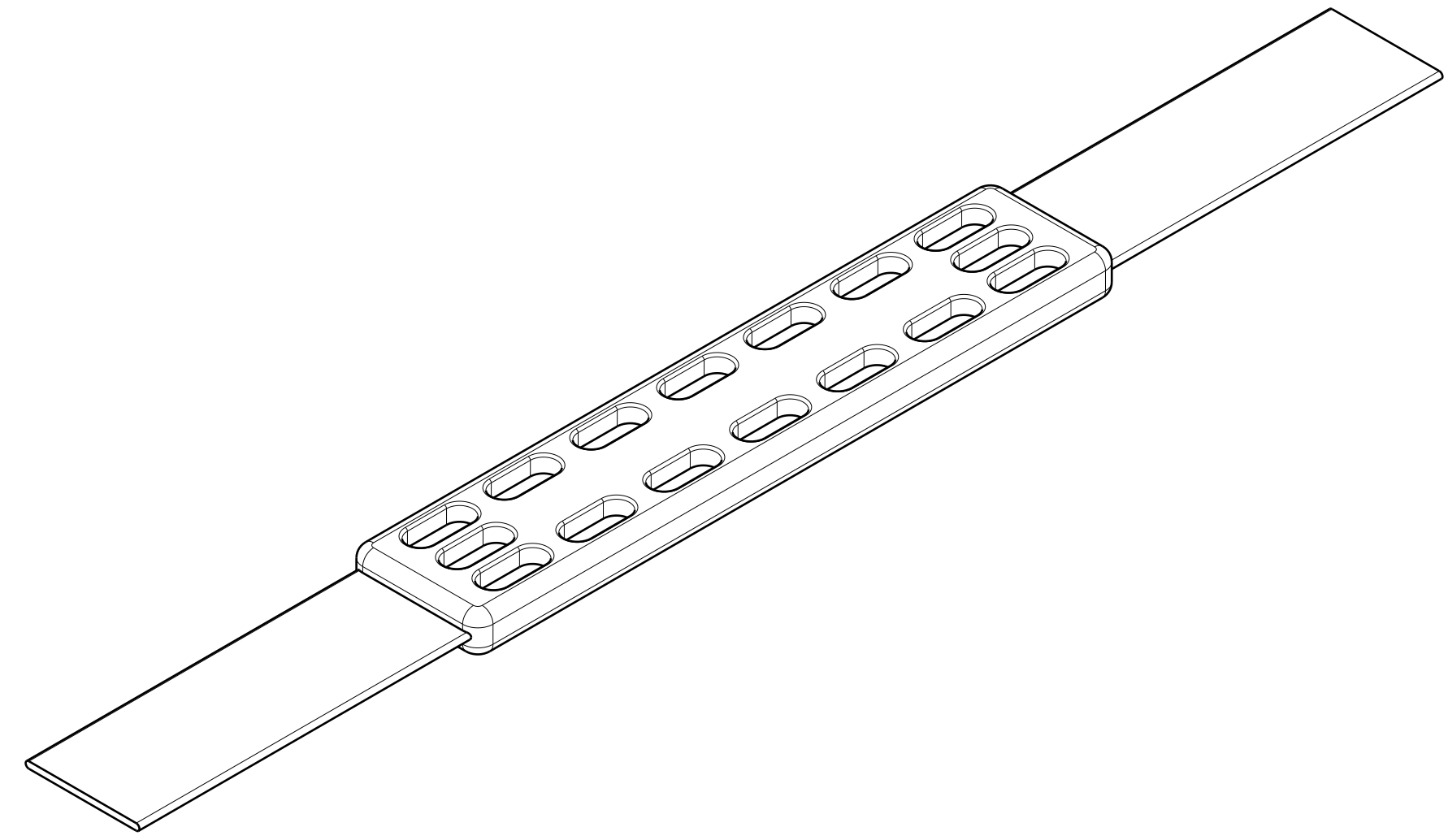

3D View

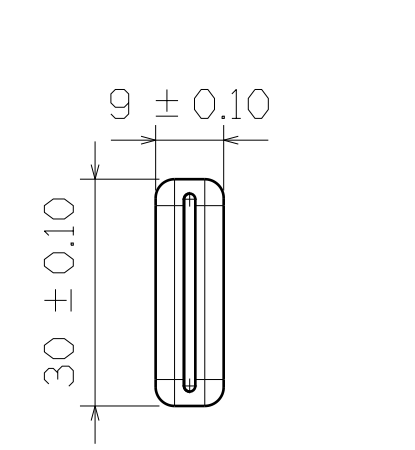

Right View

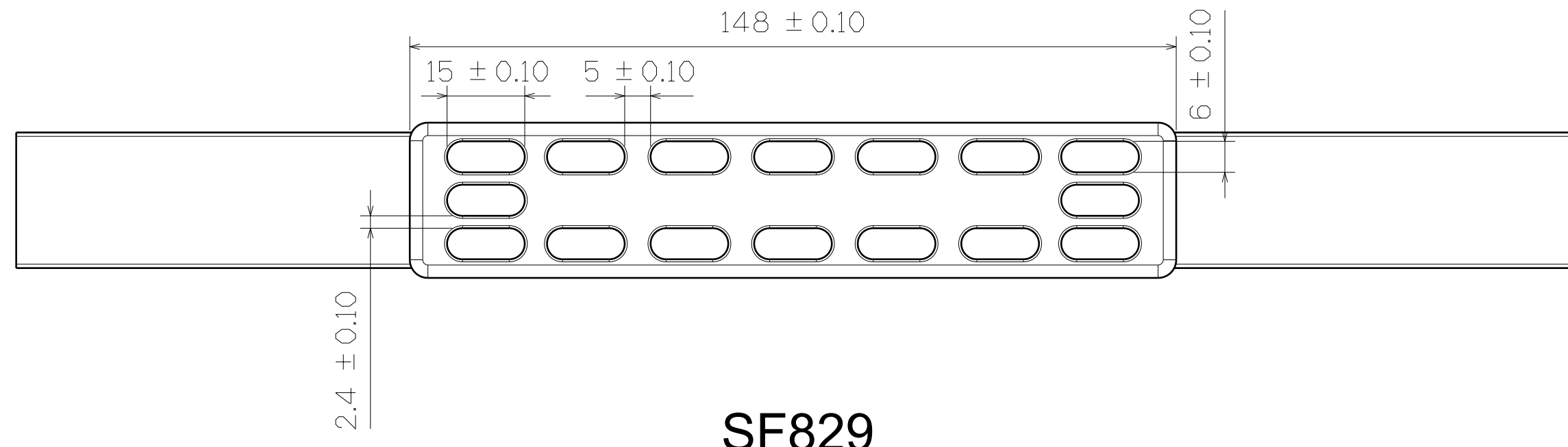

SF829

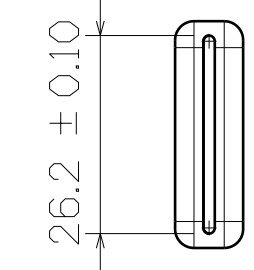

Left View

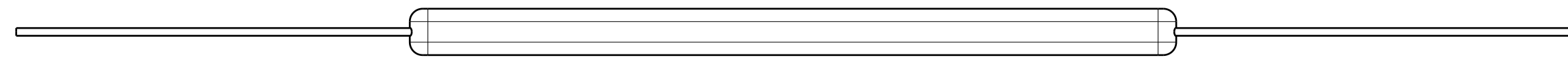

Bottom View

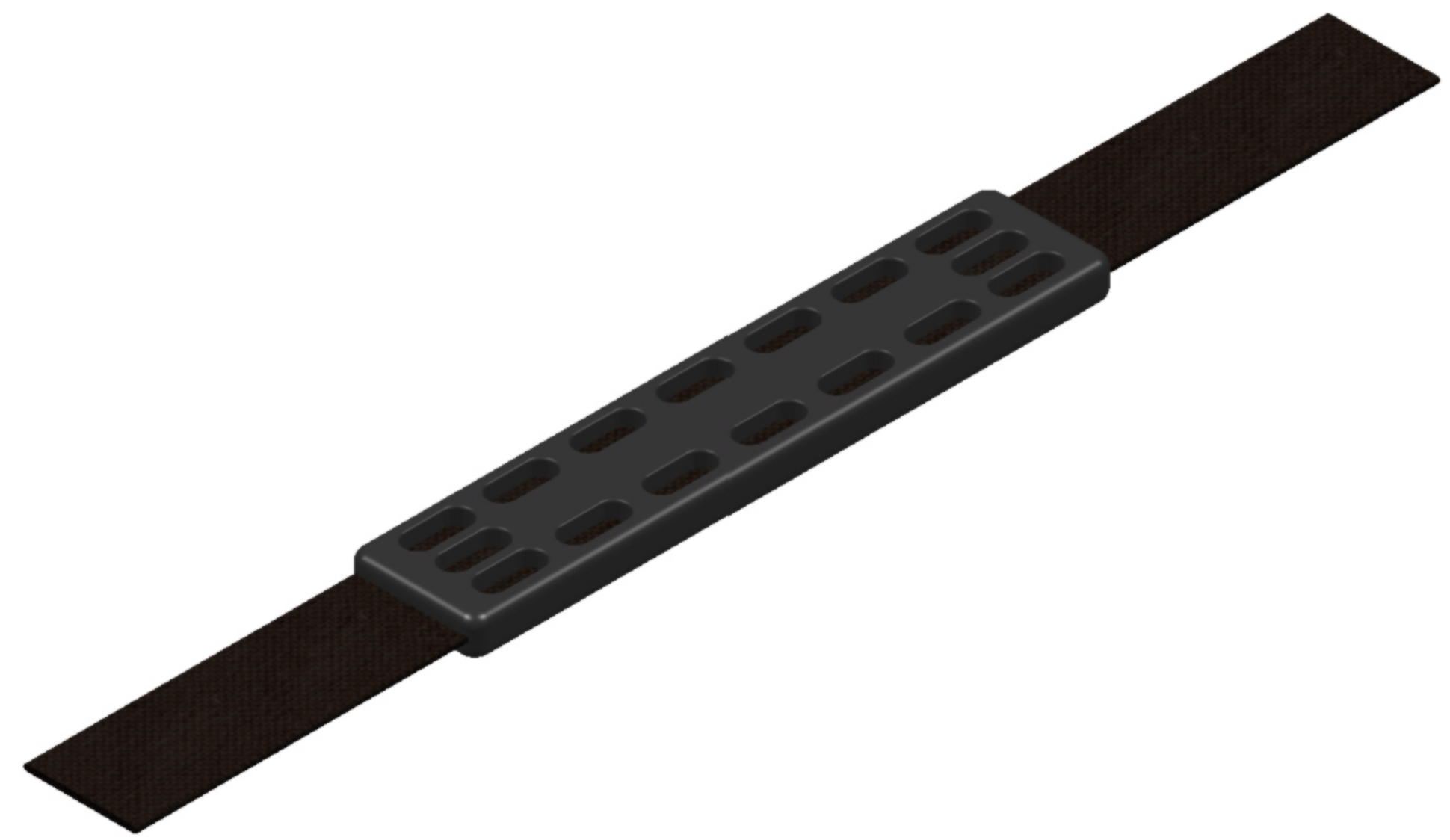

This drawing is our property. It can't be reproduced or communicated without our written agreement.					
DRAWN BY		DATE		DRAWING TITLE	
DANIEL CHEN		2009/8/17		Webbing Handle	
CHECKED BY		DATE		SIZE	DRAWING NUMBER
JIMMY CHEN		2009/8/17		A1	SF829
DESIGNED BY		DATE		SCALE	MATERIAL
RD		2009/8		1:1	PVC
				SHEET	1/1