

D

C

B

A

4

4

3

3

2

2

1

1

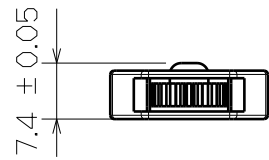

Top View

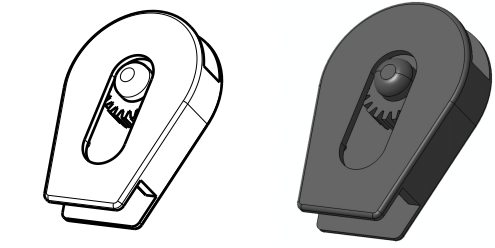

3D View

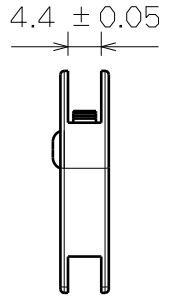

Right View

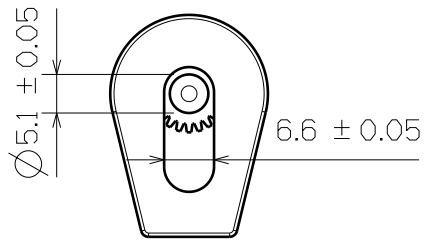

SF641

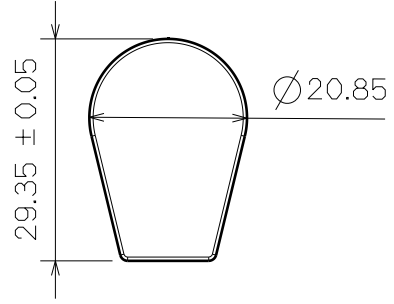

Back View

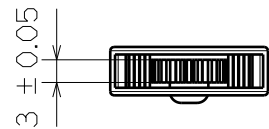

Bottom View

This drawing is our property. It can't be reproduced or communicated without our written agreement.		 <b>SHIN FANG PLASTIC INDUSTRIAL CO., LTD.</b>			
DRAWN BY		DRAWING TITLE			
BRIAN CHEN		Cord Stopper			
DATE		SIZE		DRAWING NUMBER	
1999/3/18		A4		SF641	
CHECKED BY		DATE		REV	
JIMMY CHEN		1999/3/19		X	
DESIGNED BY		DATE		SCALE	
RD		1999/3		1:1	
		MATERIAL		SHEET	
		POM		1/1	

D

A