

H G F E D C B A

4

4

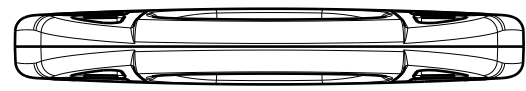

Top View

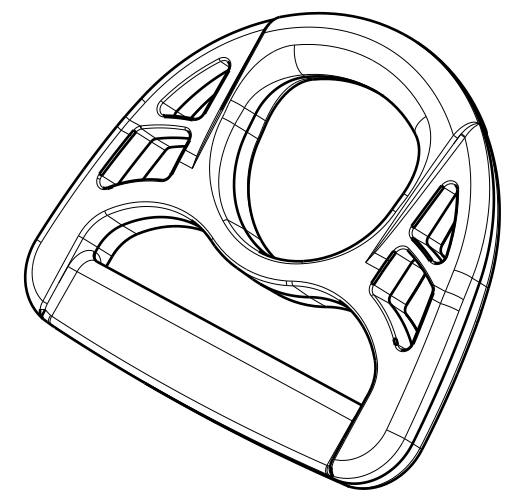

3d View



3

3

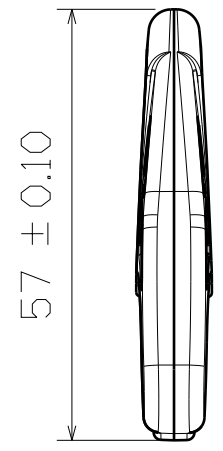

Right View

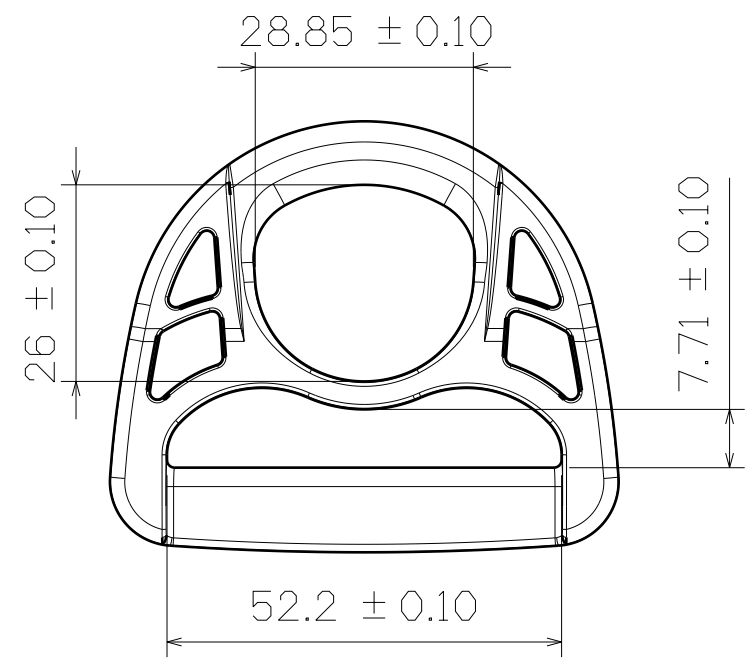

SF444-51mm

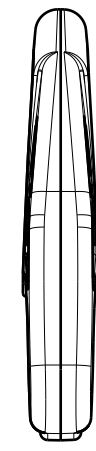

Left View

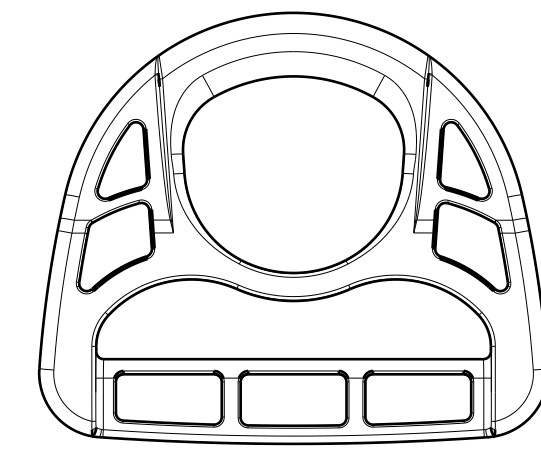

Back View

2

2

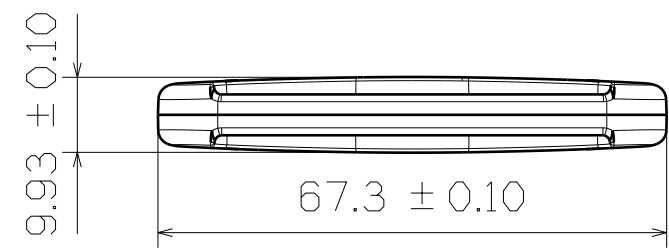

Bottom View

1

1

This drawing is our property.  
It can't be reproduced  
or communicated without  
our written agreement.

 欣芳塑膠工業有限公司  
SHIN FANG PLASTIC INDUSTRIAL CO.,LTD.

DRAWN BY <b>DANIEL CHEN</b>		DATE 2014/1/24		DRAWING TITLE <b>D-RING</b>			
CHECKED BY <b>JIMMY CHEN</b>		DATE 2014/1/24		SIZE <b>A3</b>	DRAWING NUMBER <b>SF444-51MM</b>		REV <b>X</b>
DESIGNED BY <b>RD</b>		DATE 2014/1		SCALE <b>1:1</b>	MATERIAL <b>POM</b>	SHEET <b>1/1</b>	

H G F E D C B A