

H

G

F

E

D

C

B

A

4

4

3

3

2

2

1

1

H

G

B

A

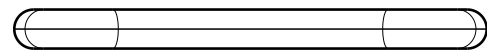

TOP VIEW

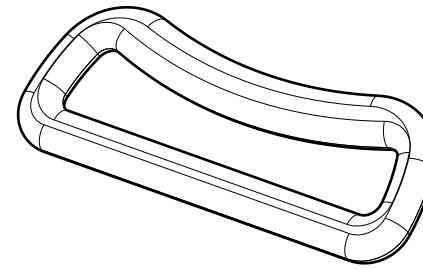

3D VIEW

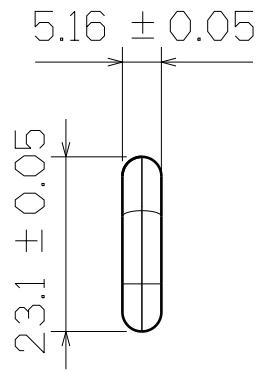

RIGHT VIEW

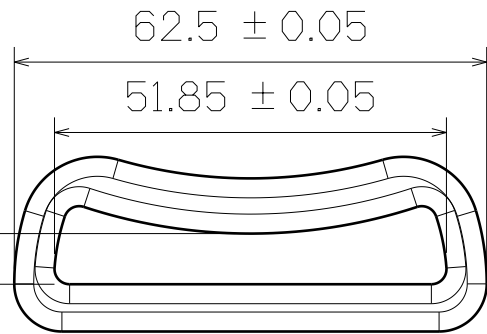

SF434-51MM

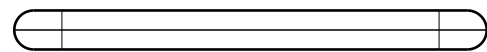

BOTTOM VIEW

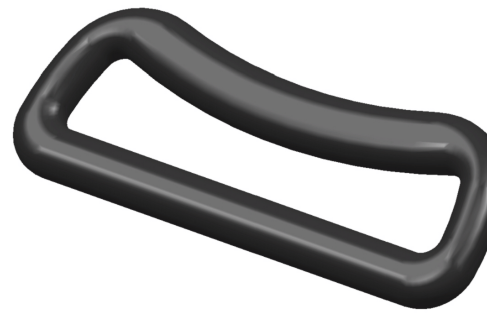

This drawing is our property. It can't be reproduced or communicated without our written agreement.		 <b>SHIN FANG PLASTIC INDUSTRIAL CO., LTD.</b>			
DRAWN BY <b>DANIEL CHEN</b>		DATE 2006/4/2		DRAWING TITLE <b>LOOP</b>	
CHECKED BY <b>JIMMY CHEN</b>		DATE 2006/4/5		SIZE <b>A3</b>	REV <b>X</b>
DESIGNED BY <b>RD</b>		DATE 2006/4		DRAWING NUMBER <b>SF434-51MM</b>	
SCALE <b>1:1</b>		MATERIAL <b>PE</b>		SHEET <b>1/1</b>	