

D

C

B

A

4

4

3

3

2

2

1

1

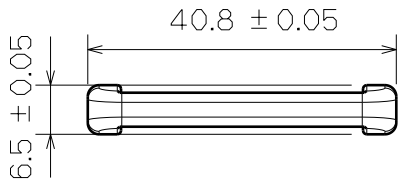

Top View

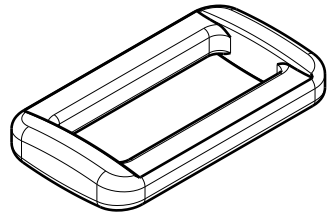

3D View

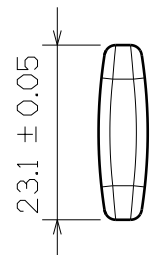

Right View

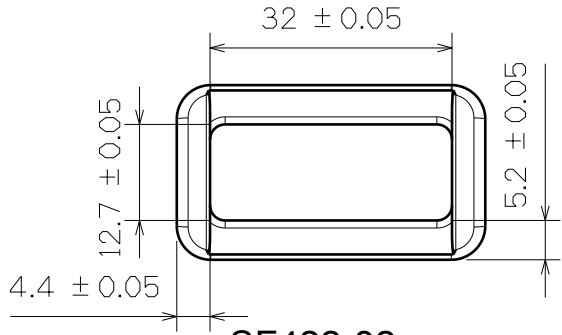

SF422-32mm



This drawing is our property. It can't be reproduced or communicated without our written agreement.		 <b>SHIN FANG PLASTIC INDUSTRIAL CO., LTD.</b>			
DRAWN BY <b>DANIEL CHEN</b>		DATE 1999/2/5		DRAWING TITLE <b>SQUARE LOOP</b>	
CHECKED BY <b>JIMMY CHEN</b>		DATE 1999/2/7		SIZE <b>A4</b>	REV <b>X</b>
DESIGNED BY <b>RD</b>		DATE 1999/2		DRAWING NUMBER <b>SF422-32mm</b>	
		SCALE <b>1:1</b>	MATERIAL <b>POM</b>	SHEET <b>1/1</b>	

D

A