

3D VIEW

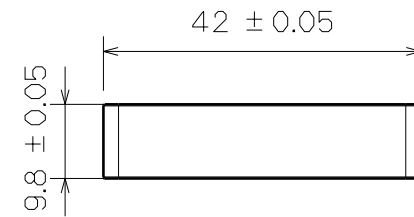

BOTTOM VIEW

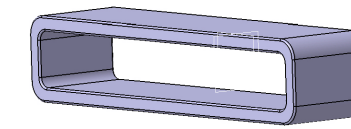
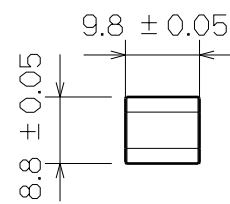

RIGHT SIDE VIEW

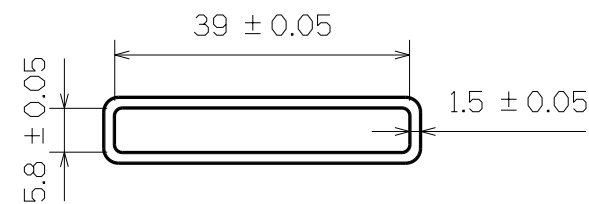

FRONT VIEW

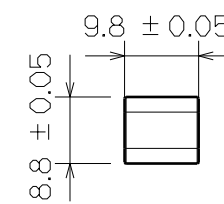

LEFT SIDE VIEW

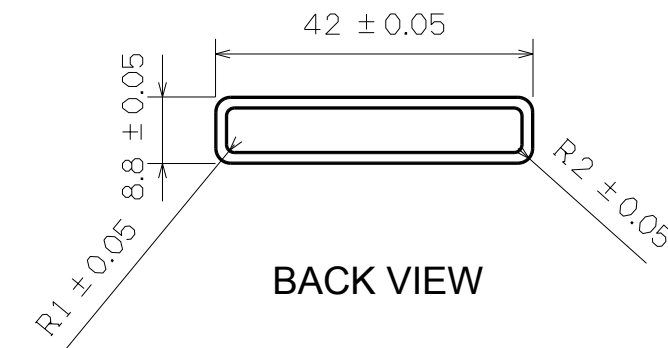

BACK VIEW

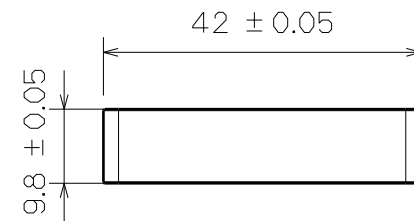

TOP VIEW

This drawing is our property.
It can't be reproduced
or communicated without
our written agreement.

欣芳塑膠工業有限公司
SHIN FANG PLASTIC INDUSTRIAL CO.,LTD.

DRAWN BY		DATE		DRAWING TITLE		
JIMMY CHEN		2011/03/18		BELT LOOP		
CHECKED BY		DATE		SIZE	DRAWING NUMBER	REV
DANIEL CHEN		2011/03/18		A3	SF405	X
DESIGNED BY		DATE		SCALE	MATERIAL	SHEET
RD		2011/03		1:1	POM or LDPE	1/1