

D C B A

4

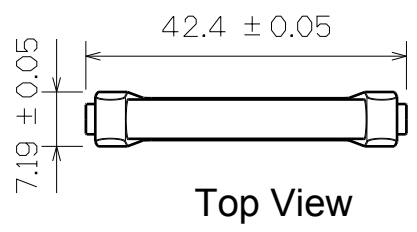

Top View

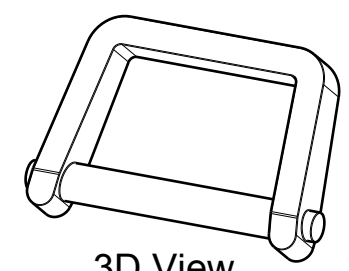

3D View

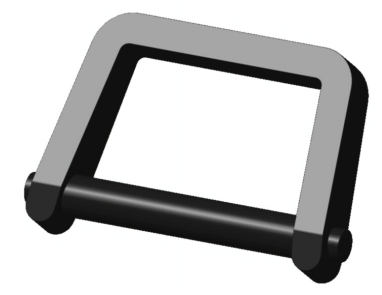

3

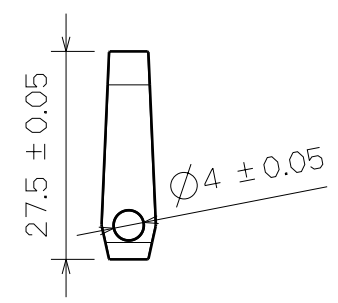

Right View

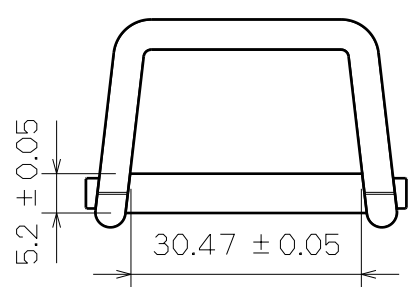

SF404-32mm

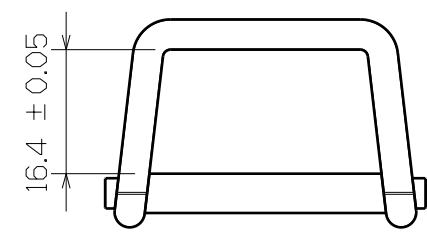

Back View

2

2

This drawing is our property. It can't be reproduced or communicated without our written agreement.		 <b>SHIN FANG PLASTIC INDUSTRIAL CO., LTD.</b>				
DRAWN BY <b>DANIEL CHEN</b>		DATE 2000/6/9		DRAWING TITLE <b>SQUARE LOOP</b>		
CHECKED BY <b>JIMMY CHEN</b>		DATE 2000/6/11	SIZE <b>A4</b>		DRAWING NUMBER <b>SF404-32MM</b>	REV <b>X</b>
DESIGNED BY <b>RD</b>		DATE 2000/6	SCALE <b>1:1</b>	MATERIAL <b>POM</b>	SHEET <b>1/1</b>	

1

1

D A