

D

C

B

A

4

4

3

3

2

2

1

1

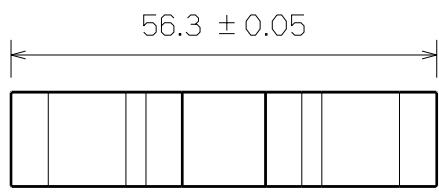

Top View

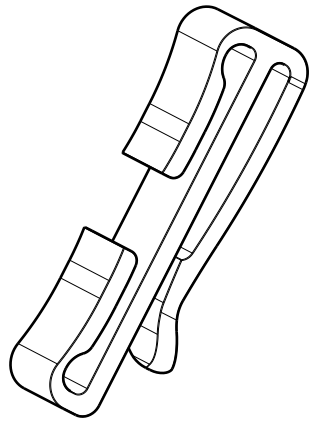

3D View

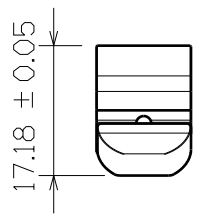

Right View

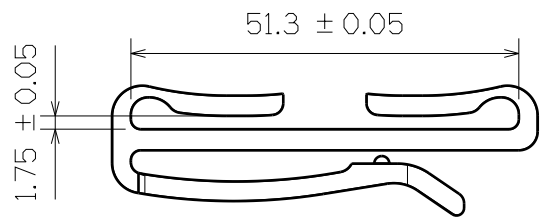

SF325-51mm

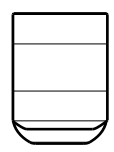

Left View

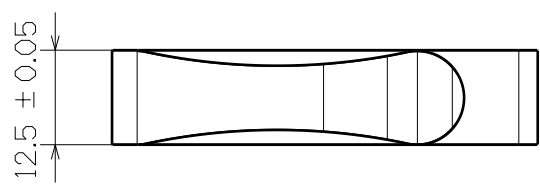

Bottom View

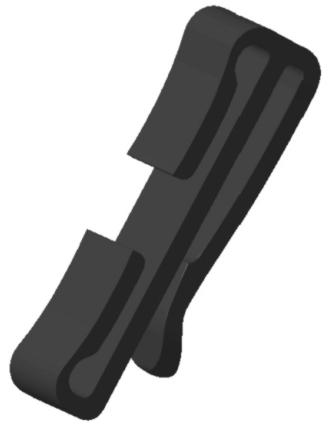

This drawing is our property.
It can't be reproduced
or communicated without
our written agreement.



**SHIN FANG PLASTIC
INDUSTRIAL CO., LTD.**

DRAWN BY	DATE
DANIEL CHEN	1995/5/11
CHECKED BY	DATE
JIMMY CHEN	1995/5/13
DESIGNED BY	DATE
RD	1995/5

DRAWING TITLE			
BELT CLIP			
SIZE	DRAWING NUMBER		REV
A4	SF325-51MM		X
SCALE	MATERIAL	SHEET	1/1
1:1	POM		

D

A