

Right View

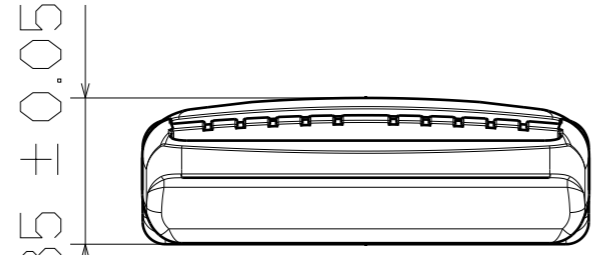

Top View

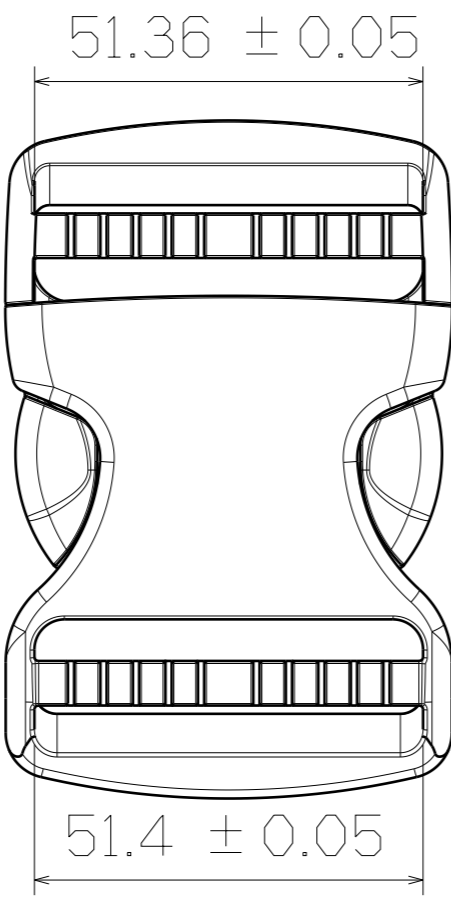

SF228-51mm

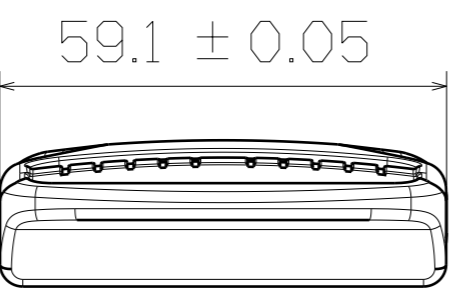

Bottom View

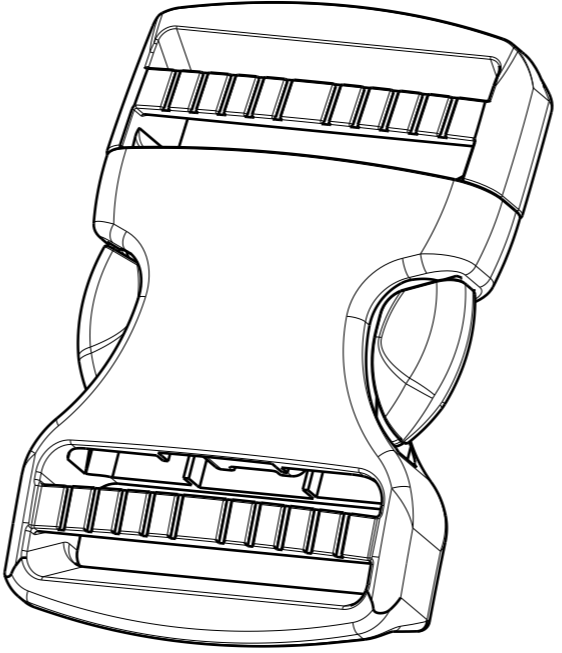

3D View

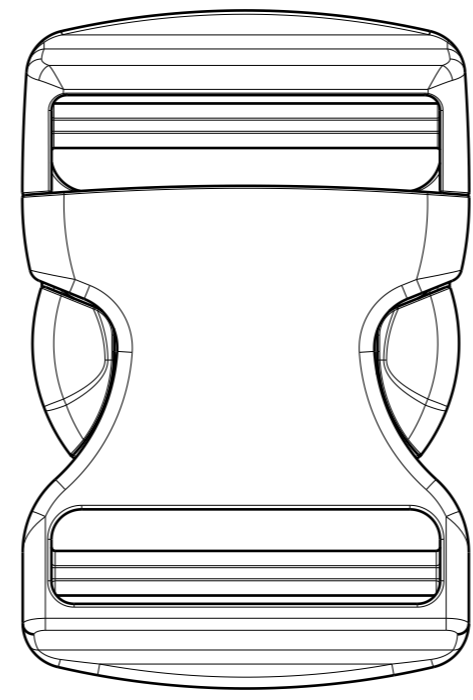
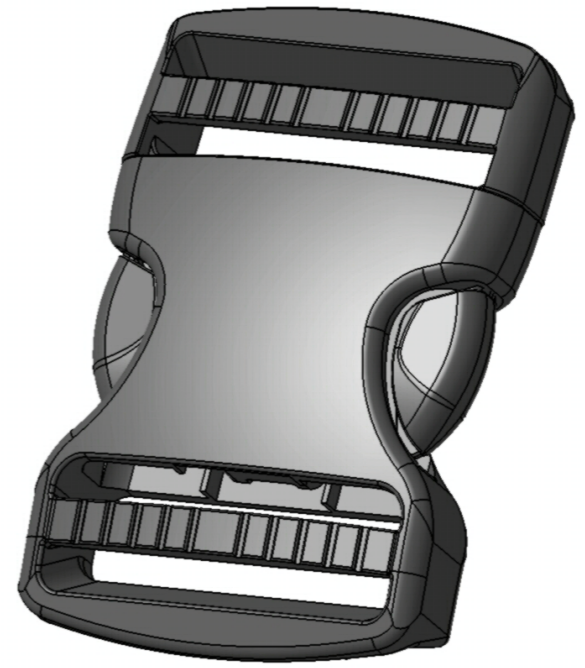

Back View

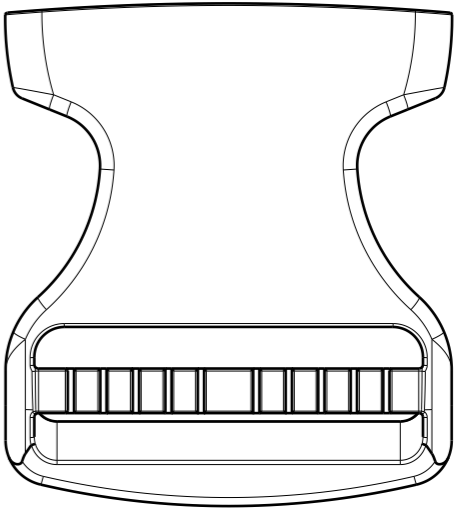
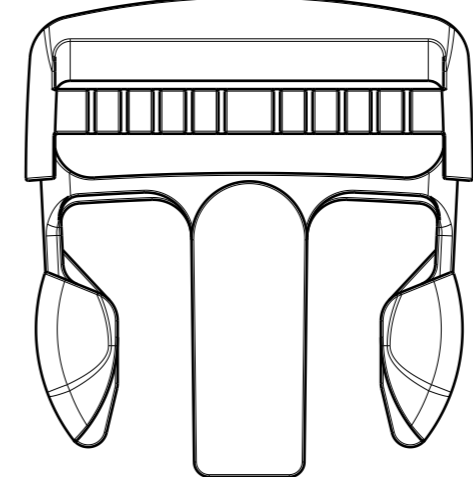

This drawing is our property. It can't be reproduced or communicated without our written agreement.					
DRAWN BY		DATE		DRAWING TITLE	
DANIEL CHEN		1995/9/5		DUAL ADJUSTABLE SIDE RELEASE BUCKLE	
CHECKED BY		DATE		SIZE	DRAWING NUMBER
JIMMY CHEN		1995/9/8		A2	SF228-51MM
DESIGNED BY		DATE		SCALE	MATERIAL
RD		1995/9		1:1	POM
				SHEET	1/1