

H G F E D C B A

4

4

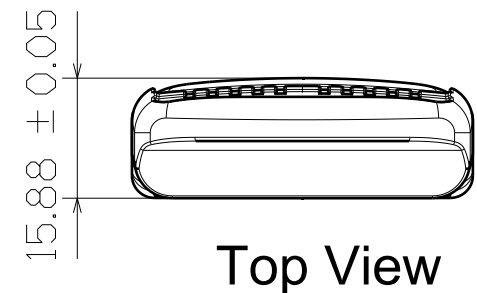

Top View

39 ± 0.05

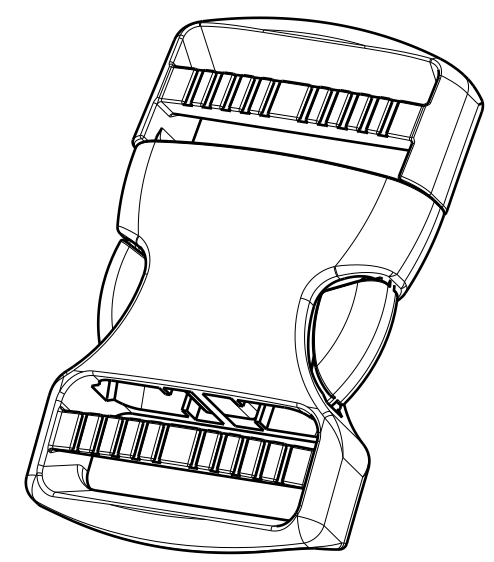

3D View



3

3

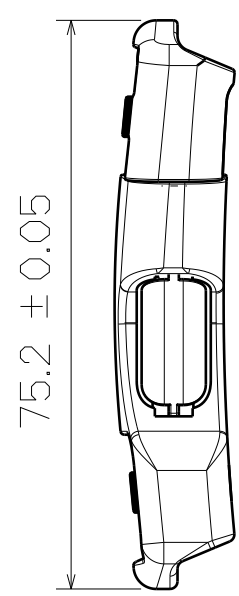

Right View

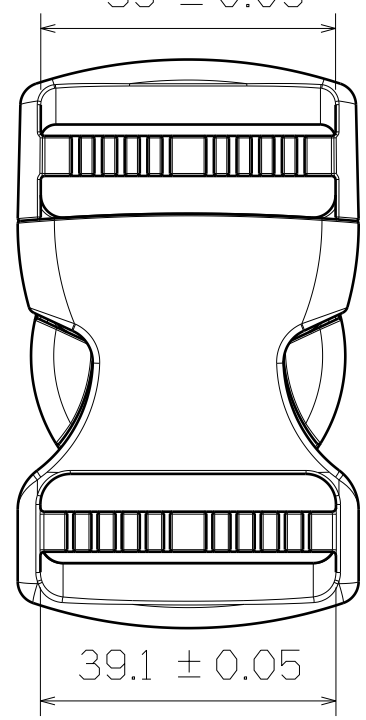

SF228-38mm

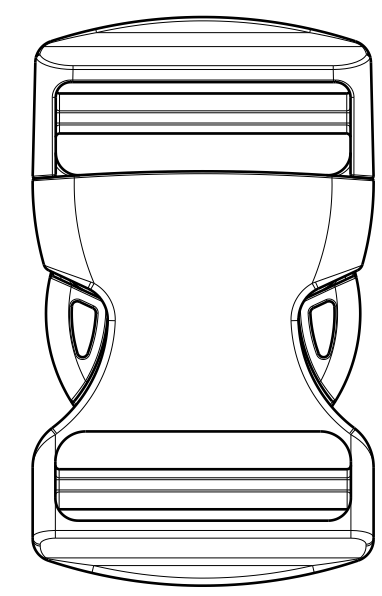

Back View

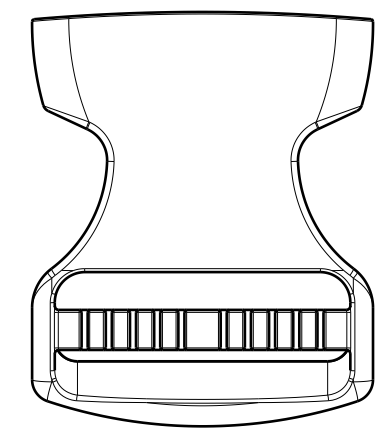
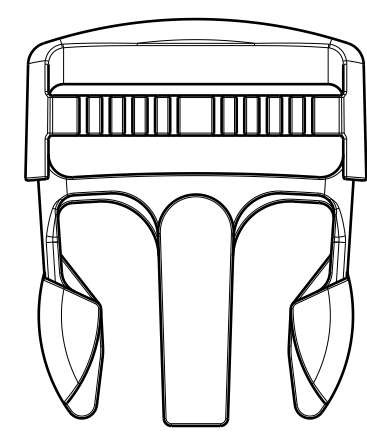

2

2

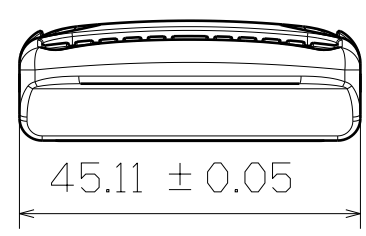

Bottom View

This drawing is our property.
It can't be reproduced
or communicated without
our written agreement.



**SHIN FANG PLASTIC
INDUSTRIAL CO., LTD.**

DRAWN BY		DATE		DRAWING TITLE			
DANIEL CHEN		1995/9/8		DUAL ADJUSTABLE SIDE RELEASE BUCKLE			
CHECKED BY		DATE		SIZE	DRAWING NUMBER		REV
JIMMY CHEN		1995/9/10		A3	SF228-38MM		X
DESIGNED BY		DATE		SCALE	1:1	MATERIAL	POM
RD		1995/9		SHEET	1/1		

1

1

H G F E D C B A